

COBHAM

SAILOR 4300 L-Band System

User manual



SAILOR 4300 L-Band System

User manual

Document number: 98-159912-D

Release date: 24 October 2019

Disclaimer

Any responsibility or liability for loss or damage in connection with the use of this product and the accompanying documentation is disclaimed by Thrane & Thrane A/S. The information in this manual is provided for information purposes only, is subject to change without notice and may contain errors or inaccuracies. Manuals issued by Thrane & Thrane A/S are periodically revised and updated. Anyone relying on this information should acquire the most current version e.g. from www.cobham.com/satcom, **Cobham SYNC Partner Portal**, or from the distributor. Thrane & Thrane A/S is not responsible for the content or accuracy of any translations or reproductions, in whole or in part, of this manual from any other source. In the event of any discrepancies, the English version shall be the governing text.

Thrane & Thrane A/S is trading as Cobham SATCOM.

Manufacturer address

Thrane & Thrane A/S, Industrivej 30, DK-9490, Pandrup, Denmark

Copyright

© 2019 Thrane & Thrane A/S. All rights reserved.

Trademark Acknowledgements

- SAILOR is a registered trademark of Thrane & Thrane A/S in the European Union and the United States of America and other countries.

GPL notification

The software included in this product contains copyrighted software that is licensed under the GPL/LGPL. The verbatim licenses can be found online at:

<http://www.gnu.org/licenses/old-licenses/gpl-2.0.html>

<http://www.gnu.org/licenses/old-licenses/lgpl-2.1.html>

You may obtain the complete corresponding source code from us for a period of three years after our last shipment of this product, which will be no earlier than 2021, by sending a money order or check for DKK 50 to:

SW Technology/GPL Compliance,
Cobham SATCOM (Thrane & Thrane A/S),
Lundtoftegaardsvej 93D
2800 Lyngby
DENMARK

Write "source for product SAILOR 4300 L-Band System" in the memo line of your payment. This offer is valid to anyone in receipt of this information.

<http://www.cobham.com/communications-and-connectivity/satcom/free-and-open-source-software-foss/>

Warranties

Any attempt to install or execute software not supplied by Cobham SATCOM on this device will result in the warranty being void. Any attempt to modify the software on this device in a way not specified by Cobham SATCOM will result in the warranty being void.

FCC & IC

NOTICE:

This device complies with Part 15 of the FCC Rules and with Industry Canada licence-exempt RSS standard(s).

Operation is subject to the following two conditions:

- (1) this device may not cause harmful interference, and
- (2) this device must accept any interference received, including interference that may cause undesired operation.

Le présent appareil est conforme aux CNR d'Industrie Canada applicables aux appareils radio exempts de licence. L'exploitation est autorisée aux deux conditions suivantes:

- (1) l'appareil ne doit pas produire de brouillage, et
- (2) l'appareil doit accepter tout brouillage radioélectrique subi, même si le brouillage est susceptible d'en compromettre le fonctionnement.

NOTICE:

Changes or modifications made to this equipment not expressly approved by Thrane & Thrane A/S may void the FCC authorization to operate this equipment.

Safety summary

The following general safety precautions must be observed during all phases of operation, service and repair of this equipment. Failure to comply with these precautions or with specific warnings elsewhere in this manual violates safety standards of design, manufacture and intended use of the equipment. Thrane & Thrane A/S assumes no liability for the customer's failure to comply with these requirements.

Microwave radiation hazards

During transmission the antenna in this system radiates Microwave Power. This radiation may be hazardous to humans close to the antenna. During transmission, make sure that nobody gets closer than the recommended minimum safety distance.



The minimum safety distance to the antenna is 0.7 m, based on $\text{max Eirp} = 46.4\text{dBm} + 1\text{dB}$. No hazard exists $> 25^\circ$ below the antenna's mounting plane. Refer to the drawing below.

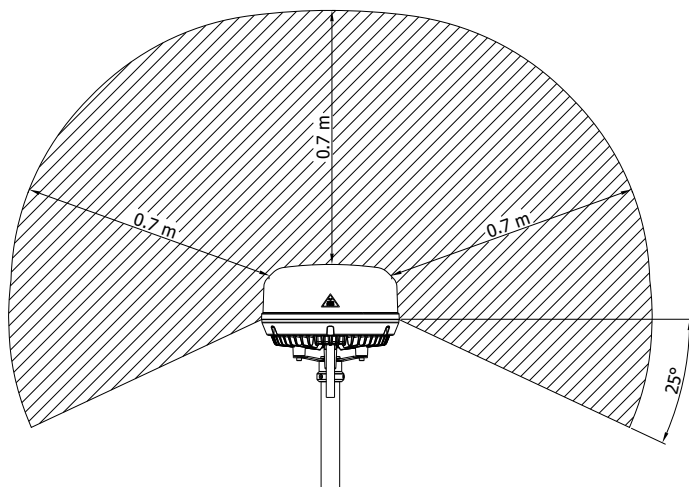

Service

User access to the interior of the terminal is not allowed. Only a technician authorized by Cobham SATCOM may perform service - failure to comply with this rule will void the warranty. Access to the interior of the antenna is not allowed. Replacement of certain modules and general service may only be performed by a technician authorized by Cobham SATCOM.

Do not operate in an explosive atmosphere

Do not operate the equipment in the presence of flammable gases or fumes. Operation of any electrical equipment in such an environment constitutes a definite safety hazard.

Failure to comply with the rules above will void the warranty!

Preface

Approvals and standard compliance

The SAILOR 4300 L-Band System is approved according to RED 2014/53/EU and FCC part 25. The approvals of the SAILOR 4300 L-Band System are constantly monitored. New national approvals will be applied for and granted and new test standards may come into force. Therefore the above list may not be complete. Contact your authorized dealer for more information.

About the manual

Intended readers

This manual is a user manual for the SAILOR 4300 L-Band System. This manual is intended for anyone who is using or intends to use this system. No specific skills are required to operate the SAILOR 4300 L-Band System. However, it is important that you observe all safety requirements listed in the beginning of this manual, and operate the system according to the guidelines in this manual. Note that this manual does not cover installation of the system. For information on installation refer to the installation manual. Part numbers for related manuals are listed in the next section.

Table of contents

Chapter 1 Introduction

General description	1
Overview	1
SAILOR 4338A Below Deck Unit (BDU)	1
SAILOR 4352A Above Deck Unit (ADU)	1
Data sessions and voice calls	2
IMEI and IMSI number	3
Part numbers	4

Chapter 2 Operation

Getting started	5
To insert the SIM card	5
Power on	6
To connect a PC and SIP phone	7
Connecting to the Internet	10
Mobile web interface	10
Start a data session	11
Making a voice call	12
Call from the terminal	12
Call to the terminal	12
Emergency call	12

Chapter 3 Service & maintenance

Maintenance	13
Contact for support	13
Status information in the mobile web interface	14
Troubleshooting	15
Introduction	15
Light indicators	16
BITE events (warning sign)	19
To restart the terminal	24

Table of contents

	Service and repair	25
	Disposal	25
App. A	Specifications	
	SAILOR 4300 L-Band System	27
Glossary	31
Index	33

Introduction

This chapter contains the following sections:

- *General description*
- *Part numbers*

General description

Overview

The SAILOR 4300 L-Band System consists of an ADU (Above Deck Unit) and a BDU (Below Deck Unit). The two units are connected with a single coax cable with TNC connectors. The system is DC powered. The SAILOR 4300 L-Band System is used for voice calls and data sessions.



Data rates and coverage

Iridium OpenPort Services offer up to 134/134 kbps, while Iridium Certus 350 Services offer up to 176/352 kbps. Iridium has 100% global coverage. Some countries may have national restrictions.

SAILOR 4338A Below Deck Unit (BDU)

The BDU is the central unit in the system. It contains all user interfaces and handles all communication between the ADU and the local communication units (phones, computers etc.).

SAILOR 4352A Above Deck Unit (ADU)

The ADU consists of an antenna with an RF-unit, unit for antenna control and GPS antenna. The ADU is dedicated to the Iridium system.

Data sessions and voice calls

The SAILOR 4300 L-Band System provides data connection and up to three simultaneous IP voice calls. Both data and voice services is accessed through the service and the three user LAN ports depending on configuration.

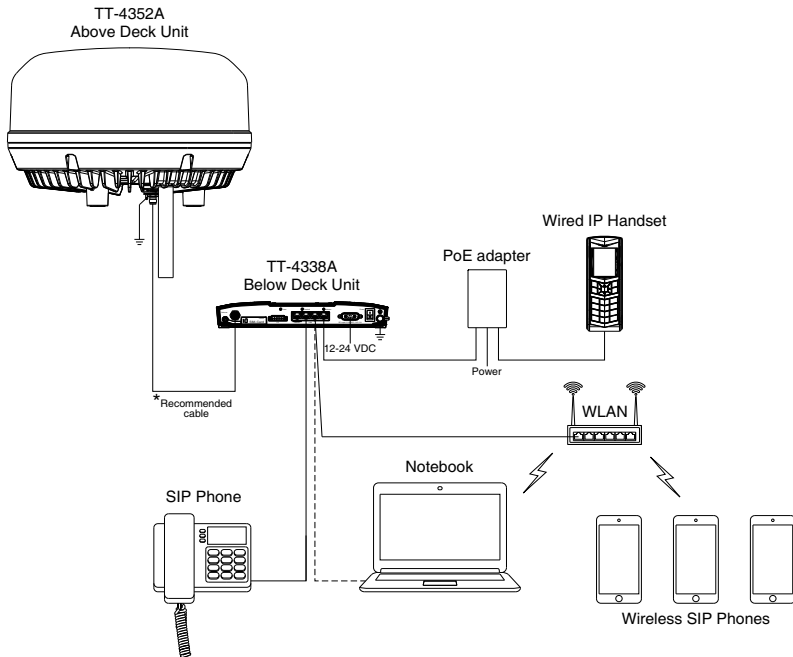

* Connector type: TNC
Cable requirements:
- Installation on bigger vessels: RG214/U up to 100 m length
- Installation in a mechanically protected environment and shorter distances: RG223/U up to 25 m length

Data services are available on any of the LAN ports. The Certus data service define multiple data flows as shown in the table below:

Name	Services
Post-paid	Data, voice and DHCP server
Secondary 1	Data
Secondary 2	Data
Secondary 3	Data
Secondary 4	Data

All user ports are default attached to Post-paid data flow. A user port can be attached to any other flow depending on configuration.

Each flow has three modes: off, manual (default) and automatic. If a flow is in manual mode, the data session is stopped on terminal startup and can easily be started and stopped from the Service or Mobile web interface. If a flow is in automatic mode, the data session will automatically start when traffic is detected. Automatic mode is persistent across reboots.

The BDU communicates directly with SIP phones on any of the LAN ports. The terminal SIP server is available on the Post-paid data flow only.

IMEI and IMSI number

The terminal has an IMEI number which is stored by Iridium. The IMEI is printed on the ADU type label. The IMSI number is printed on the SIM card which you have received from your airtime provider.

Part numbers

This manual is for the SAILOR 4300 L-Band System and is applicable to the following part numbers:

Part number	Description
404338A-00500	SAILOR 4338A Below Deck Unit (Bulk)
404338A-00510	SAILOR 4338A Below Deck Unit (19" rack)
404352A-00500	SAILOR 4352A Above Deck Unit

Operation

This chapter has the following sections:

- *Getting started*
- *Connecting to the Internet*
- *Making a voice call*

Getting started

To insert the SIM card

To be able to use the terminal you must have a valid SIM card. The SIM card is administrated by your airtime provider.



1. Locate the slot for the SIM card.
2. Slide the SIM card lock to free the SIM card slot.
3. Insert the SIM card with the chip side facing down.
4. Press gently until it clicks into place.
5. Slide the lock in front of the SIM card slot.

Power on

Depending on which of the three possible power switch configurations is installed on the ship, the product is powered up as follows:

- Using the on/off switch in the front panel of the SAILOR 4338A Below Deck Unit (bulk), see the following table.

Power on/off	Front Switch	Remote switch
OFF	OFF	Not Used
OFF	ON	Make
ON	ON	Not Used
ON	ON	Break

- Using the on/off switch on the SAILOR 4338A Below Deck Unit (19" rack), see the following table.

Power on/off	Front Switch	Rack Switch	Remote switch
OFF	OFF	x	x
OFF	ON	OFF	Make
OFF	ON	ON	Make
OFF	ON	OFF	Not Used
OFF	ON	OFF	Break
ON	ON	ON	Not Used
ON	ON	ON	Break

- Using a remote on/off control (2 pin input in the Sub-D input connector). See the two tables above.

In the following sections only normal BDU configuration is shown. The terminal is DC powered (12-24 VDC).

To power up the system, do as follows:

1. Power up the system, i.e. switch on the terminal.

Note

The first couple of seconds there is no light in the Power LED.
Wait until there is light in the Power LED.



2. Wait until the LEDs at the rear of the terminal show that the system is ready to be accessed.
 - Power LED: Green.
 - Terminal: Steady green.
 - Antenna: Steady green.
3. The system is ready for use.

To connect a PC and SIP phone

Connect your equipment to the Ethernet connector(s) marked LAN. You need a straight LAN cable.

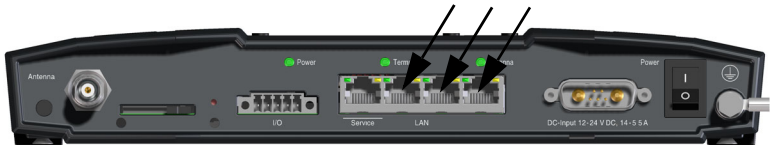

The available services on each LAN port depends on terminal configuration and service provider. Contact your service provider for further information

SIP telephony service

The SAILOR 4300 L-Band System has a built-in SIP server which provides up to three voice lines to users connected to the BDU. To use this service you need one or more VoIP-phone or soft-phone (mobile apps, PC software). The effective number of available voice lines depends on the subscription. Each voice line has a dedicated mobile number and is available through one

of the internal SIP user names line1, line2 and line3. The mapping from subscribed mobile number to the SIP user name is fixed. For an example see the following table.

Mapping from subscribed mobile numbers			
User name	Mobile number	Line type	Voice quality
line1	8816xxxxxxx1	PostPaid	HQ
line2	8816xxxxxxx2	PostPaid	HQ
line3	8816xxxxxxx3	PostPaid	HQ

See your subscription information for the exact details on which mobile number is assigned to which user name.

To connect one or more VoIP-phone or soft-phone (mobile apps, PC software), do as follows:

1. In order to use the telephony service connect a SIP or VoIP enabled telephone to a user port of the BDU and register it with the built-in SIP server.
2. If a router or wireless access point is used to connect the telephone, make sure that the required protocols for VoIP telephony is forwarded. You can find a list of these protocols at the end of this chapter.
3. For the registration on the BDU a number of network-specific parameters are necessary, which are stored in a "SIP profile" in the telephone. At least configure the following items:

Network-specific parameters		
Item	Value	Description
User name	line1, line2 or line3	Select the user name assigned to the mobile phone number that shall be used.
Password	[leave empty]	No password required.
SIP server	172.16.0.1	This is the default address. If the address does not work contact the administrator for the correct one.

Note | For details of how to configure your device consult the telephone's user manual.

Important

You cannot register more than one telephone on the same mobile number respective user name on the SIP-server. If more telephones register with the same SIP-profile, only the last telephone registered will be subscribed to the mobile number and be able to use this number for receiving and making calls.

You can use all available mobile numbers and user names from within one telephone or application. That means that you can handle all your subscribed numbers from one device. Note that not all devices might support subscribing to more than one line. See the device's user manual for details.

Suitable telephones for this service are dedicated stand-alone VoIP-, IP- or SIP-telephones, or soft-phone applications running on a PC or mobile phone. A VoIP-app on a mobile phone can only be used if the phone is connected to the device via a separate wireless router. Any modern SIP-telephone or software are suited for use with the SAILOR 4300 unit, though this cannot be guaranteed for a specific type of device or software.

At least the following protocols and codecs must be supported:

Protocols and codes	
Item Name	Description
SIP protocol	SIP protocol version 2.0; internet standard RFC 3261
SDP protocol	Internet standards RFC 2327 and RFC 3264
RTP - voice streams	Internet standard RFC 1889 or RFC 3550
Voice stream format	G.711 A-law; 8000 Hz sampling rate; packet interval 20 ms
DTMF format	Internet standard RFC 4733

Connecting to the Internet

Mobile web interface

The purpose of the mobile web interface is to use the SAILOR 4300 L-Band System for starting and stopping data sessions and view system events. To access the mobile web interface use a smartphone or tablet that is connected to the terminal via the user LAN ports. The mobile web interface is intended for users of mobile devices. It consists of a subset of the functions in the service web interface. The mobile web interface is available on all LAN ports.

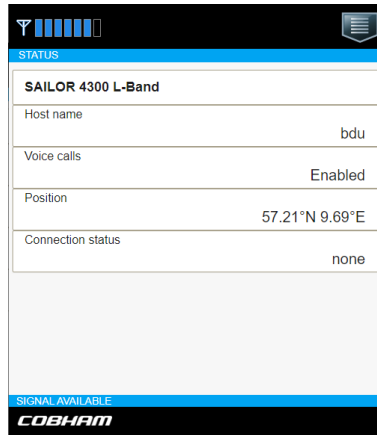

← Tap here for menus available.

Connecting to the mobile web interface

To connect to the mobile web interface, do as follows:

1. Connect a computer to one of the LAN ports (standard Ethernet) or through a smartphone via WLAN.
2. Open your Internet browser and enter the IP address of the BDU User LAN `http://172.16.0.2` (default) or Service LAN `http://192.168.0.1/mobile` (default).
3. Login details may be required depending on configuration. Contact the administrator for username and password.

Login details	
Username	<input type="text"/>
Password	<input type="password"/>
	<input type="button" value="Login"/>

Note

If service web is enabled on User LAN and the mobile web interface is accessed from PC the IP address is: `http://172.16.0.2/mobile` (default).

Menus in the mobile web interface

The mobile web interface has the following top-level menus:

- **Status** shows information such as system status, host name, position, statistics etc.
- **Data** for start or stop of a data session (if Data Mode is set to Manual during installation).
- **Voice** displays the status of voice calls.
- **Event list** shows a list of currently active warnings and errors (if any).
- **Help** opens this manual in a pdf version.
- **Logout**.

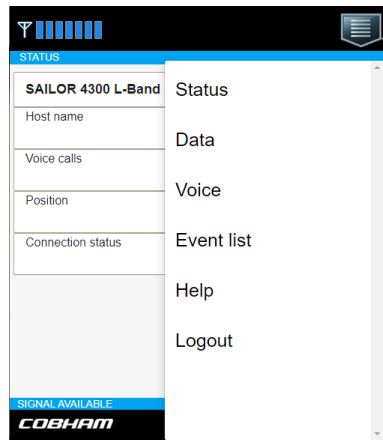

Start a data session

To be able to access the Internet you must have an active data session. A data flow can have one of three modes: off, automatic and manual. Controlling whether a data session is started or stopped through the mobile web interface can only be done in manual mode.

To start a data session manually, do as follows:

1. Open your Internet browser and enter the default IP address of the BDU User LAN <http://172.16.0.2> (default).
2. Tap the menu icon and select **Data** to start or stop a data session.
3. Tap the Start button to start data session.

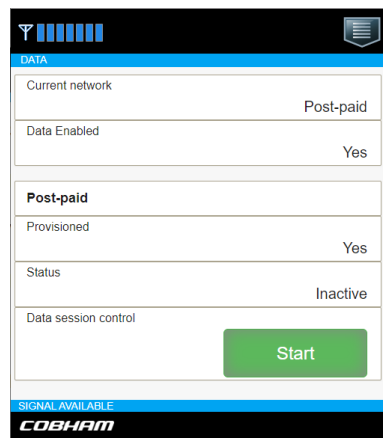

Making a voice call

Call from the terminal

To make a call from a phone connected to the SAILOR 4300 L-Band System:

Example: To call Cobham SATCOM in Denmark: (00 45 39558800): dial 00 <country code> <phone number> followed by press on call: 00 45 39558800 #.

Call to the terminal

You find the voice numbers for your terminal in your airtime subscription. To make a call to a phone connected to the SAILOR 4300 L-Band System:

Dial +<Iridium mobile number> (+ is the prefix to call out of the country you are located in).

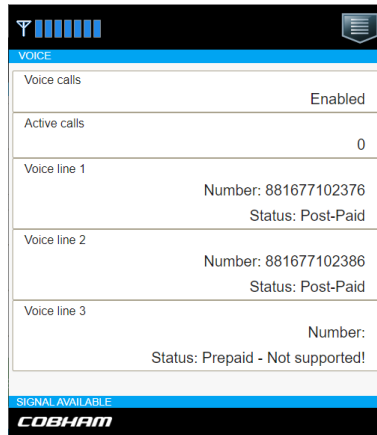

Emergency call

Iridium Certus Terminals support several emergency services internationally. Ship personnel should in general use GMDSS equipment in the event of an emergency.

Service & maintenance

This chapter has the following sections:

- *Maintenance*
- *Troubleshooting*
- *Service and repair*

Maintenance

Maintenance of the SAILOR 4300 L-Band System can be reduced to a maintenance check at each visit of the service staff. Inspect the unit for mechanical damages, salt deposits, corrosion and any foreign material. Due to its robust construction and ruggedness the unit has a long lifetime. Anyway it must carefully be checked at intervals not longer than 12 months – dependent on the current working conditions.

Contact for support

Contact an authorized dealer for technical service and support of the SAILOR 4300 L-Band System. Before contacting the authorized dealer you can go through the troubleshooting guide to solve some of the most common operational problems.

Status information in the mobile web interface

To display **Status** information in the mobile web interface, do as follows:

1. Open the mobile web interface on your device.
2. The current status is displayed.

The overall state of the system is always displayed at the bottom of the mobile web interface. The following states are shown:

- **INITIALIZING.** The system is initializing itself.
- **SELF TESTING.** Self test is performed after start up.
- **READY.** The system is ready for operation.
- **SEARCHING.** The system is searching for available satellites.
- **SIGNAL AVAILABLE.** Satellite signal is available from at least one candidate satellite. Ready to connect.
- **CONNECTED.** The system is registered and connected to the satellite network. Ready to use.
- **DENIED.** Registration on the network was denied. The denial cause will appear on the status page. Check also SIM card status matches the requested service.
- **OVERHEATING.** System is overheated. System is halted in 30 seconds.
- **ERROR.** A critical error is detected. See event list.
- **UPDATING FIRMWARE.** Firmware update is in progress.
- **REBOOTING.** The system is rebooting.
- **NOT RESPONDING. REBOOTING?.** The system is currently not responding. Can be caused by a manual power cycle or loss of connection.

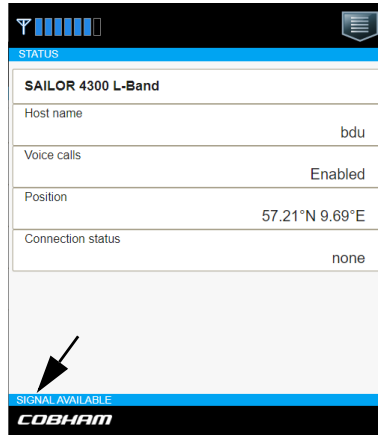

In case a warning sign is displayed in the top bar, you can tap on it to display the current system events.

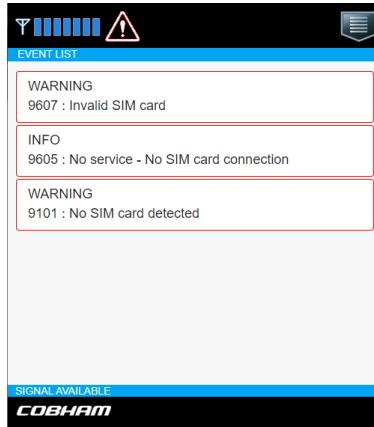

The latest version of this manual is available in PDF format via the HELP menu. The manual will either be displayed immediately or it will be available in the download folder (depending on the browser or mobile device used).

Troubleshooting

Introduction

In this section you find possible root causes to the experienced errors and suggestions for a remedy. Listed are only errors that may be caused by wrong installation, wrong configuration or misuse of the product. Errors where no remedy is listed could indicate damaged equipment. If failing to restore normal system status contact your service partner. The following sources for system validation are available:

- *Light indicators*
- *BITE events (warning sign)*

Light indicators

The BDU terminal has several indicator LEDs. They indicate the overall system status during normal use.

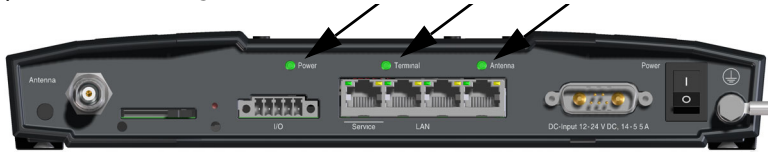

Power LED

Indicator pattern	State	Remedy
Off	Power off	Check if power is present. See section <i>Power on</i> on page 6.
On (Green)	Power on	Normal operation.

Terminal LED

The terminal LED shows the status of the BDU, ADU and Iridium modem. In case of an error (red), this could be an error in the BDU, ADU or Iridium modem.

Indicator pattern	State	Remedy
Off	Power off	Check if power is present.
Blue	System initialization	The BDU initializes and powers the ADU. The system waits until a successful connection between BDU and ADU has been established.

Indicator pattern	State	Remedy
Green flashing	Self-test (BDU and ADU POST)	The terminal and antenna is not yet ready (while performing Power On Self Test). This state may remain for approximately 60 seconds (it is not an error). If the state persists restart the system.
Yellow steady	Warning User recoverable	User recoverable continuous warning event detected, see active BITE event in the web interface as described in the section <i>BITE events (warning sign)</i> on page 19.
Green steady	Terminal ready	The terminal is operational and ready for use.
Red steady	Error (BDU, ADU or Iridium modem)	A fatal error is detected in the system. If possible, read out the event list. If a critical temperature is detected (overheating in the BDU) the product may be restarted after cooling has been provided. On other failures see the section <i>BITE events (warning sign)</i> on page 19 or contact your service partner.

Antenna LED

The antenna LED shows the status of the ADU and the Iridium link connection. In case of an error (red), it could be an error in the ADU or Iridium modem.

Indicator pattern	Meaning	Remedy
Off	Power off	Check if power is present.
Blue steady	Initializing (ADU/Iridium modem start-up and self-tests)	The antenna is not yet ready. This state may remain for approximately 120 seconds (this is not an error). If the state persists restart the unit).

Indicator pattern	Meaning	Remedy
Yellow flashing	Searching	Normal system state, see <i>Status information in the mobile web interface</i> on page 14.
Green flashing	Signal available	Normal system state, see <i>Status information in the mobile web interface</i> on page 14.
Green steady	Connected	Normal system state, see <i>Status information in the mobile web interface</i> on page 14.
Yellow steady	Denied	Service is denied on the Iridium network. Check SIM card status matches the requested service.
Red steady	Error (ADU or Iridium modem)	A fatal error is detected in the system. See active BITE POST event in the web interface as described in the section <i>BITE events (warning sign)</i> on page 19.

Ethernet LEDs

The Ethernet RJ45 connectors have two LEDs built-in, Green and Yellow.

Indicator pattern	Meaning	Green - Remedy
Off	Power off or 10 Mbps	Check the LAN cable connection to PC or handsets. Check that handsets are not connected to the service port (left most).
On	100 Mbps	Normal.

Indicator pattern	Meaning	Yellow - Remedy
Off	Power off or no link pulse	Check LAN cable connection to PC or handsets. Check that handsets are not connected to the service port (left most).
On steady	Link	Normal
Flashing	Traffic	Normal

BITE events (warning sign)

BITE events are shown in the event list. The following table shows suggestions how to deal with the events.

BITE ID (HEX)	System component symptom	Remedy
8301 8302	ADU GPS module has no connection ADU GPS module has no fix.	Restart the terminal and see below. Inspect the ADU and check all cables. Compare position shown on Status page with vessel's main GPS.
8401 8402	ADU Temperature above warning level ADU Temperature above critical level.	The system will automatically decrease the transmit performance on temperature warnings. On detection of critical temperatures the system will protect itself by powering off the ADU. After a cool down period (30 minutes) the system will automatically restart.

BITE ID (HEX)	System component symptom	Remedy
8403 8404 8405 8406 8407 8408 8409 840A	ADU internal voltage errors.	Contact your service partner.
840B 840C	ADU PSU temperature above warning level ADU PSU temperature above critical level.	<p>The system will automatically decrease the transmit performance on temperature warnings.</p> <p>On detection of critical temperatures the system will protect itself by powering off the ADU. After a cool down period (30 minutes) the system will automatically restart.</p>
840D 840E	ADU Antenna switch temp. above warning level. ADU Antenna switch temp. above critical level.	<p>The system will automatically decrease the transmit performance on temperature warnings.</p> <p>On detection of critical temperatures the system will protect itself by powering off the ADU. After a cool down period (30 minutes) the system will automatically restart.</p>
8501	No communication to Iridium modem.	Restart the terminal (see below).
8502	Iridium modem critical fault detected.	Restart the terminal (see below).

BITE ID (HEX)	System component symptom	Remedy
8503	High power amplifier control fault detected.	Restart the terminal. If persistent contact service partner.
8601 8602	HPA Temperature above warning level HPA Temperature above critical level.	The system will automatically decrease the transmit performance on temperature warnings. On detection of critical temperatures the system will protect itself by powering off the ADU. After a cool down period (30 minutes) the system will automatically restart.
8A01	ADU boot-up problem. System services may be not available.	Restart the terminal (see below).
8C01	ADU GPS module has no connection.	Restart the terminal (see below).
8D01 8D02 8D03 8D04 8D05	ADU integrity check and configuration check failure.	Restart the terminal (see below). Contact your service partner and await instructions for reporting.
9001	BDU ADU communication check error.	Inspect antenna cable connection between BDU and ADU. Restart the terminal (see below).

BITE ID (HEX)	System component symptom	Remedy
9002 9003	BDU temperature above warning level. BDU temperature above critical level.	On temperature warnings try to provide sufficient ventilation to the terminal (opening lockers, check fans, etc.). On detection of critical temperatures the system will halt completely after 30 seconds. Manual restart is required after cooling has been provided.
9004 9005 9006 9007 9008 9009 900A	BDU Internal voltage errors.	Contact your service partner.
900C 900D	BDU PSU temperature above warning level. BDU PSU temperature above critical level (System will enter a protection state).	On temperature warnings try to provide sufficient ventilation to the terminal (opening lockers, check fans, etc.). On detection of critical temperatures the system will halt completely after 30 seconds. Manual restart is required after cooling has been provided.
9101	BDU SIM card reader empty. No service.	Insert a valid SIM card.
9102	BDU cannot connect to the Iridium modem.	Restart the terminal (see below). Contact your service partner.

BITE ID (HEX)	System component symptom	Remedy
9104 9105 9106 9107 9108	Data connection not possible.	Contact Iridium service provider if the issue is present after a reboot.
9601	Iridium modem reports a reboot.	Observe the number of this event and report the event, if persistent, to your service partner.
9602 9603	Iridium modem temperature above warning level. Iridium modem temperature above critical level.	The system will automatically decrease the transmit performance on temperature warnings. On detection of critical temperatures the system will protect itself by powering off the ADU. After a cool down period (30 minutes) the system will automatically restart.
9604	Reduced number of active time slots.	None. Automatic recovery mode to prevent critical temperature.
9605	No SIM card connection.	Check SIM card or contact service partner.
9606	Service Denied.	See denial cause on status page. Contact service provider.
9607	Invalid SIM card detected.	Replace the SIM card, try the SIM card in another terminal or replace BDU.
9801 9802	BDU integrity check and configuration check failure.	Restart the terminal (see below). Contact your service partner and await instructions for reporting.

BITE ID (HEX)	System component symptom	Remedy
9803 9804	Unit firmware upgrade mismatch.	Restart the terminal (see below). If persistent contact your service partner.
9901	BDU SIM module reader error.	Contact your service partner.
9902	Iridium modem self-check error.	Contact your service partner.
9903	Iridium modem reports wrong antenna type configuration.	Contact your service partner.
9A01	BDU boot-up problem. System services may be not be available.	Restart the terminal (see below).

To restart the terminal

To restart the terminal, power-cycle it, see *Power on* on page 6.

Service and repair

Should your Cobham SATCOM product fail, please contact your dealer or installer, or the nearest Cobham SATCOM partner. You will find the partner details on www.cobham.com/satcom, **Technical Service Partner List**. You can also access the **Cobham SYNC Partner Portal** at <https://sync.cobham.com/satcom>, which may help you solve the problem. Your dealer, installer or Cobham SATCOM partner will assist you whether the need is user training, technical support, arranging on-site repair or sending the product for repair. Your dealer, installer or Cobham SATCOM partner will also take care of any warranty issue.

Applicable SAILOR part numbers

See *Part numbers* on page 4.

Disposal

Old electrical and electronic equipment marked with this symbol can contain substances hazardous to human beings and the environment. Never dispose these items together with unsorted municipal waste (household waste). In order to protect the environment and ensure the correct recycling of old equipment as well as the re-utilization of individual components, use either public collection or private collection by the local distributor of old electrical and electronic equipment marked with this symbol.



Contact the local distributor for information about what type of return system to use.

Specifications

SAILOR 4300 L-Band System

Item	Specification
Weight, BDU	3.5 kg
Weight, BDU, 19"	3.8 kg
Weight, ADU	9.5 kg
Dimensions, BDU	48 x 27 x 4 cm
Dimensions, BDU, 19"	48 x 49 x 4 cm
Dimensions, ADU	ø=38 cm, H=37 cm
Minimum safety distance	0.7 m
APPROVALS	
Iridium NEXT approved. Compliant to RED, CE Marked. Tested to FCC part 25	
FREQUENCY BAND	
Operating frequency range	1616 - 1626.5 MHz
Number of channels	30 sub bands + 0.5 MHz paging
Channel spacing	333.333 kHz
Output power	15.4 dBw
Bandwidth	41.667 kHz, 83.333 kHz, 333.333 kHz, 666.666 kHz
ITU Emission Designator	41K7Q1W,83K3Q1W,333KQ1W,333KQ7W,666KQ7W
Type of radio transmission	Frequency divide and multi carrier

Appendix A: Specifications

Item	Specification
Types of modulation	QPSK, 16APSK, SE-QPSK multi carrier
Number of antennas	7
Antenna gain	8.7 dB
RECOMMENDED ANTENNA CABLE	
Recommended antenna cable	RG214U up to 100 m
Requirements for antenna cable	<10 dB loss at 80 MHz. Max. 1.8 Ohm DC loop resistance
POWER SUPPLY AND CONSUMPTION	
Voltages	10.8 V to 31.2 VDC
Power consumption (max)	120 W @ 10.8-31.2 VDC
Heat dissipation for BDU	15 W max.
Current consumption	Approx. 4Aavg/15Apeak at 12VDC, 2Aavg/8Apeak at 24VDC
ENVIRONMENTAL CONDITIONS	
Operating temperature	-25 to +55°C
Storage temperature	-35 to +85°C
Survival temperature (power on, non functional)	-35 to +80°C
Automatic thermal surveillance shuts down system gradually in ease of own temperature	
BDU operating humidity	5% to 95% non-condensing at +40°C
ADU enclosure	IPX6
ADU operating humidity	5% to 95% Exposed according to EN 60945
BDU enclosure	IP31
Icing (survival)	Max 25 mm

Item	Specification
VIBRATION (ADU)	
Vibration, operational	Random spectrum 0.92 g rms x 3 axes: 5 to 20 Hz: 0.01 g ² /Hz 20 to 500 Hz: -3 dB/octave
Vibration, non-operational	Random spectrum 1.7 g rms 2 h x 3 axes (6 h total): 5 to 20 Hz: 0.05 g ² /Hz, 20 to 150 Hz: -3 dB/octave
SHIP MOTION	
Roll	+/- 30 deg. per 8 s, max. 0.5 g tan.
Pitch	+/- 15 deg. per 6 s, max. 0.5 g tan.
Yaw	+/- 10 deg. per 50 s, max. 0.2 g tan.
Surge	+/- 0.2 g
Sway	+/- 0.2 g
Heave	+/- 0.5 g
Turning rate	+/- 6°/s; ACC 1°/s ²
Headway speed	15 m/s (30 knots)
Wind	200 km/hr (108 knots)
MECHANICAL SHOCK	
Mechanical shock	20g/11 half-sine
ANTENNA CONNECTOR	
ADU	TNC, female
BDU	TNC, female
OTHER SPECIFICATIONS	
Standard IP data rate, up/down	176/352 kbps
Ethernet/LAN	4 ports
I/O connector	1 connector

Appendix A: Specifications

Item	Specification
Status LED	Full status LED panel
SIM card slot	1 SIM card slot for Iridium SIM card

A

ADU Above Deck Unit

B

BDU Below Deck Unit

G

GPL General Public License, Software license, which guarantees individuals, organizations and companies the freedom to use, study, share (copy), and modify the software.

L

LGPL Lesser General Public License

P

PSU Power Supply Unit

A

approvals, vi

C

contact
support, 13

I

IP address
for web interface, 10, 11

M

maintenance, 13

P

part numbers, 25

S

Specifications, 27
standard compliance, vi
support
contact info, 13

W

warranty, 25

